

Pressure regulator

0821302089

Screw-in pressure regulators

- Qn max. [[750] l/min]
- Width: [[11] mm] ... [[25] mm]
- Energy-saving valves for direct fitting on the cylinder

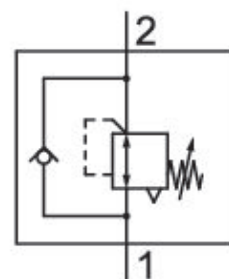

Technical data

Industry
Industrial

Type
Poppet valve

Compressed air connection input
G 1/4

Compressed air connection type input
External thread

Compressed air connection output
Ø 8

Compressed air connection type output
push-in fitting

Working pressure min.
1 bar

Working pressure max
16 bar

Regulation range min.
1 bar

Regulation range max.
8 bar

Min. ambient temperature
-10 °C

Max. ambient temperature
70 °C

Min. medium temperature
-10 °C

Max. medium temperature
70 °C

Medium
Compressed air
Qn 1 > 2
600 l/min
Weight
0.08 kg
Housing material
Brass

Polyamide
Surface housing
galvanized
Seal material
Acrylonitrile butadiene rubber
Part No.
0821302089

Technical information

The pressure dew point must be at least 15 °C under ambient and medium temperature and may not exceed 3 °C .

The min. control pressure must be adhered to, since otherwise faulty switching and valve failure may result!

The pressure dew point must be at least 15 °C under ambient and medium temperature and may not exceed 3 °C .

The oil content of compressed air must remain constant during the life cycle.

Use only the approved oils from AVENTICS. Further information can be found in the "Technical information" document (available in <https://www.emerson.com/en-us/support>).

Fig. 1

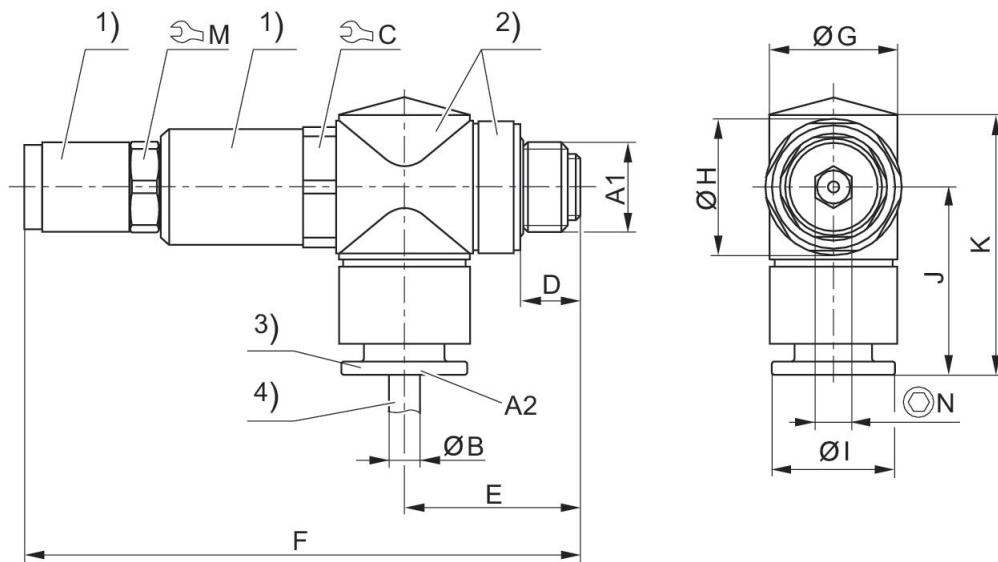

1) galvanized brass 2) polyamide 3) polyamide 4) tubing
A1 = input A2 = output

Part No.	A1	A2	C	D	E	F	G	H	I
0821302083	G 1/8	4	17	6.3	19.8	70.8	11	15	9,4

Part No.	A1	A2	C	D	E	F	G	H	I
0821302084	G 1/8	6	17	6.3	19.8	70.8	13	15	11,4
0821302085	G 1/8	8	17	6.3	19.8	70.8	14	15	13,8
0821302088	G 1/4	6	17	9.5	25.8	78.8	13	19	11,4
0821302089	G 1/4	8	17	9.5	25.8	78.8	18	19	13,8
0821302090	G 1/4	10	17	9.5	25.8	78.8	18	19	16,4

Part No.	J	K	M	N
0821302083	22,3	32	13	5
0821302084	25	35	13	5
0821302085	26.4	36.5	13	5
0821302088	26.8	38.9	13	5
0821302089	28.2	41	13	5
0821302090	28.9	41.7	13	5

Fig. 2

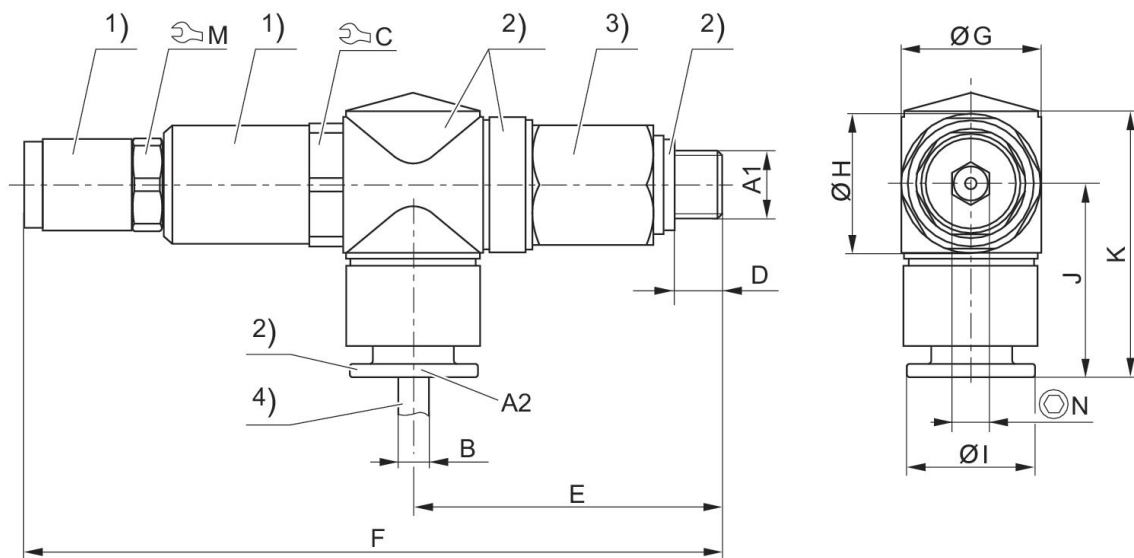

1) galvanized brass 2) polyamide 3) galvanized brass 4) tubing
A1 = input A2 = output

Part No.	A1	A2	C	D	E	F	M	I	J
0821302086	G 1/8	6	17	6.5	42.3	95.3	13	11.4	27
0821302087	G 1/8	8	17	6.2	42.3	95.3	13	13.8	28.2

Part No.	K
0821302086	39
0821302087	41

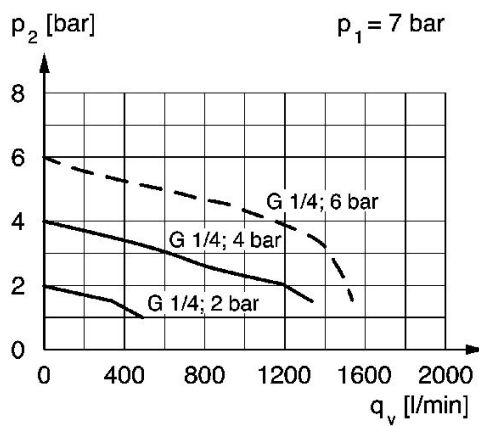

p_1 = working pressure, p_2 = secondary pressure, q_v = nominal flow

Hysteresis

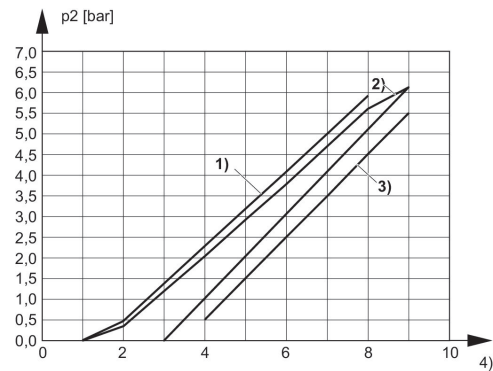

- 1) Overfill hysteresis
- 2) Control hysteresis
- 3) Refill hysteresis
- 4) Adjustment screw rotations

Pressure characteristics curve (flow rate from 1 to 2)

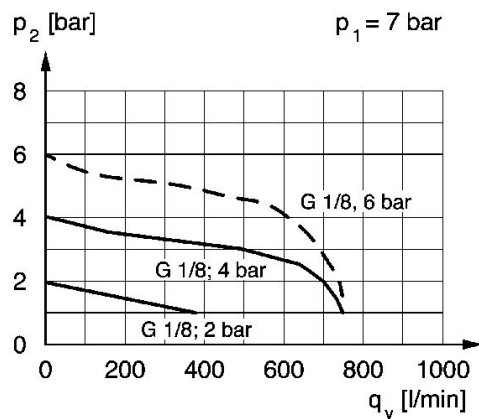

Application example

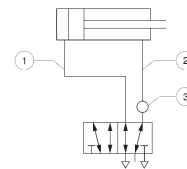

- 1) e.g. forward stroke with max. pressure
 - 2) return stroke with reduced pressure
 - 3) installation point on directional control valve
- At low tightening torque, the sealing ring enables the banjo union to swivel through 360°. Further tightening locks the banjo union into position. Adjust pressure via adjustment screw with hexagon socket. Lock using counter nuts.