

Sensor mounting, Series CB1

1827020297

General series information
AVENTICS Sensor mountings

- AVENTICS Sensors mountings are especially designed to mount AVENTICS sensors on various cylinders.



Technical data

Industry

Industrial

For series

MNI
ICM

Cylinders Ø min.

12 mm

Weight

0.01 kg

Material

Housing material

Aluminum

Part No.

1827020297

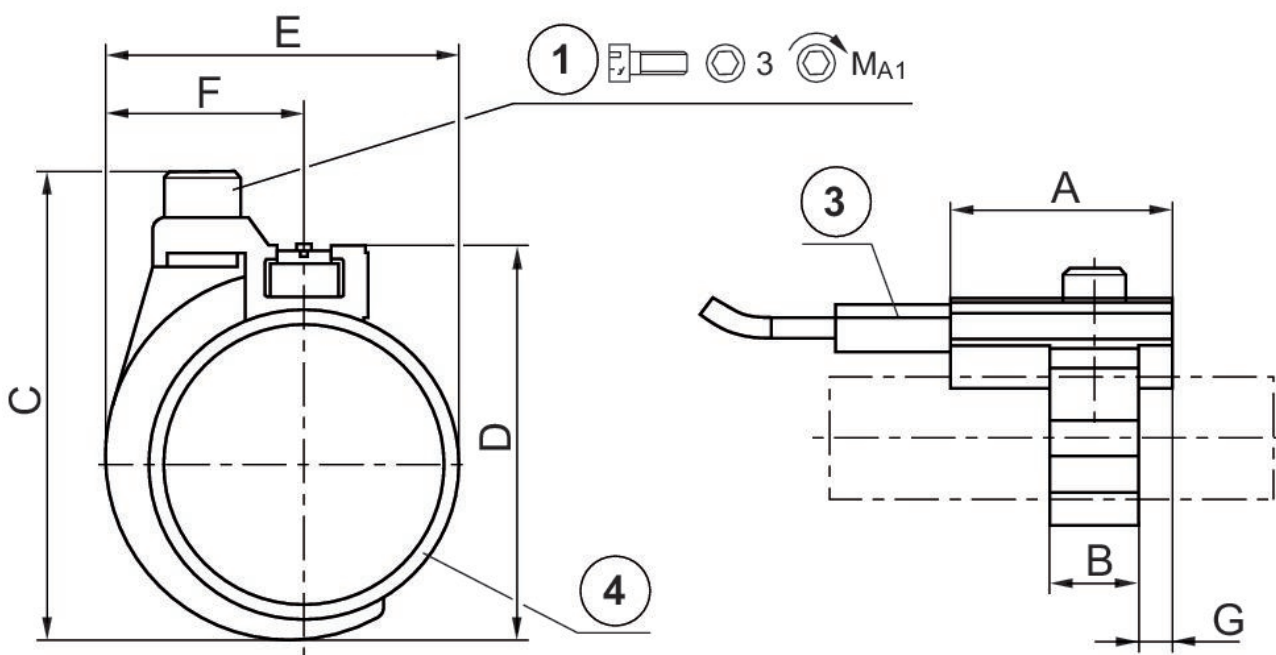
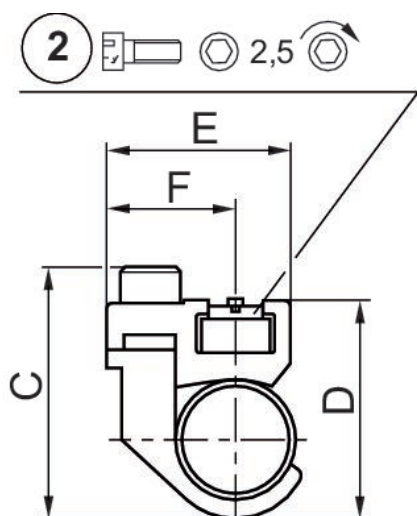

1) Mounting screw 2) Mounting screw for sensor 3) Sensor 4) Cylinder pipe

Part No.	Cylinders Ø	A	B	C	D	E	F	G	Mounting screw
1827020296	10 mm	20	8	24	19	17.5	11.8	3	M3x8
1827020297	12 mm	20	8	26	22	19	11.8	3	M3x8
1827020298	16 mm	20	12	34	30	23	13.8	4	M4x10
1827020299	20 mm	20	12	38	32	26	13.8	4	M4x10
1827020300	25 mm	20	12	43	37	31	13.8	4	M4x10

Part No.	MA1 [Nm]
1827020296	1 +0,2
1827020297	1 +0,2
1827020298	2 +0,3
1827020299	2 +0,3
1827020300	2 +0,3