

A413G15

printed on: 29-11-2022



TECHNICAL INFO

Media type	INORGANIC FIBERGLASS
Efficiency	15 $\mu\text{m}_{(c)}$ $\beta_x \geq 200$
Efficiency 1	17 $\mu\text{m}_{(c)}$ $\beta_x \geq 1000$
Max working pressure	34.5 bar
Seals	NBR
Temperature range	-30°C +100°C

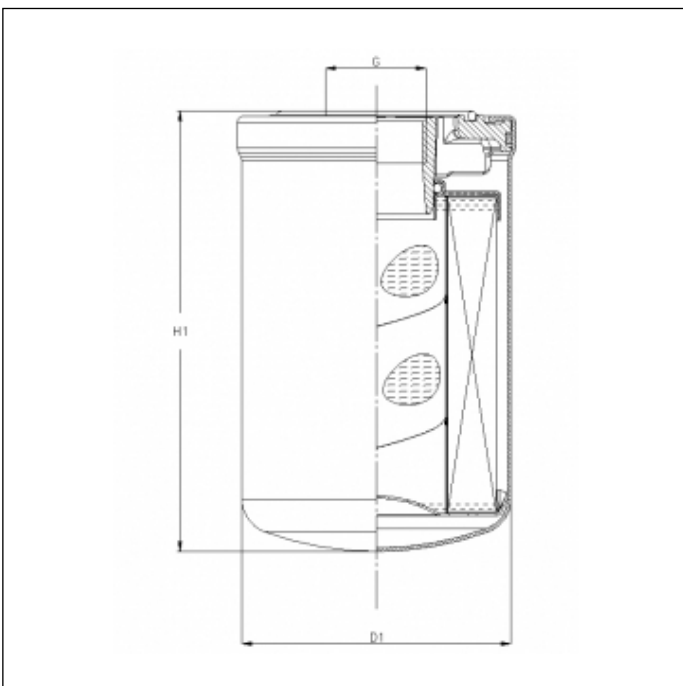

OVERALL DIMENSIONS

D1	95,0 mm
H1	241,5 mm
G	1 3/8"-12 UNF 2B

Technical information may change without notice. Image and drawing are representative only