

## SUORITUSTASOILMOITUS

### DoP 0311

fischer betoniruuville UltraCut FBS II

FI

1. Tuotetyypin yksilöllinen tunniste: **DoP 0311**
2. Aiottu käyttötarkoitus (aiotut käyttötarkoitukset): **Jälkikäteen tehtäviin kiinnityksiin muuraus, katso lisäys, erityisesti liitteet B1 - B8.**
3. Valmistaja: **fischerwerke GmbH & Co. KG, Klaus-Fischer-Str. 1, 72178 Waldachtal, Saksa**
4. Valtuutettu edustaja: **-**
5. Suoritusasteon pysyvyyden arvioinnissa ja varmentamisessa käytetty järjestelmä/käytetyt järjestelmät: **1**
6. Eurooppalainen arviointiasiakirja: **EAD 330460-00-0604, Edition 04/2022**  
Eurooppalainen tekninen arviointi: **ETA-20/0134; 2022-07-14**  
Teknisestä arvioinnista vastaava laitos: **DIBt- Deutsches Institut für Bautechnik**  
Ilmoitettu laitos/ilmoitetut laitokset: **2873 TU Darmstadt**
7. Ilmoitettu suoritusasteo/ilmoitetut suoritusasteot:  
**Mekaaninen kestävyys ja vakaus (BWR 1)**  
Yksittäisen ankkurin kestävyys ilman teräsvauriota vetokuormituksen alaisena: katso lisäys, erityisesti liitteet C1  
  
Yksittäisen ruuviankkurin teräksen ominaisvastus leikkauskuormituksessa: katso lisäys, erityisesti liitteet C1  
  
Yksittäisen ankkurin kestävyys ulosvetovauriota tai tiilen irtoamista vastaan vetokuormituksen alaisena: katso lisäys, erityisesti liitteet B6,B7,C2,C3,C5,C6,C8,C9,C11,C12  
Tyypillinen ominainen tiilen rikkoutumista tai yksittäisen ankkurin tiilen murtumisvauriota vastaan leikkauskuormituksen alaisena: katso lisäys, erityisesti liitteet B6,B7,C2,C3,C5,C6,C8,C9,C11,C12  
Usean ankkurin kestävyys tiilen murtumisvauriolle jännityskuormituksen alaisena: katso lisäys, erityisesti liitteet B6,B7,C2,C5,C8,C11  
  
Kestävyys tiilen murtumista tai ankkuriryhmän tiilen murtumisvauriota vastaan leikkauskuormituksen alaisena: katso lisäys, erityisesti liitteet B6,B7,C2,C5,C8,C11  
Reuna etäisyydet, keskinäiset välit, osan paksuus: katso lisäys, erityisesti liitteet B6,B7,C2,C5,C8,C11  
  
Yhdistetyn veto- ja leikkauskuormituksen kestävyys (ontto ja reiätetty tiili): katso lisäys, erityisesti liitteet C12  
  
Siirtymät: katso lisäys, erityisesti liitteet C3, C6, C9, C12  
  
**Turvallisuus tulipalon sattuessa (BWR 2)**  
Reaktio paloon: Luokka (A1)  
Tulenkestävyys: katso lisäys, erityisesti liitteet C4, C7, C10  
  
**Kestävyys:**  
Kestävyys:katso lisäys, erityisesti liitteet A3, B1
8. Asianmukainen tekninen asiakirja ja/tai tekninen erityisasiakirja: **-**

Edellä yksilöidyn tuotteen suoritusasteo on ilmoitettujen suoritusasteojen joukon mukainen. Tämä suoritusasteoilmoitus on asetuksen (EU) N:o 305/2011 mukaisesti annettu edellä ilmoitetun valmistajan yksinomisella vastuulla.

Valmistajan puolesta allekirjoittanut:



Dr.-Ing. Oliver Gelbig, Toimitusjohtaja Liiketoimintayksikkö & Suunnittelu  
Tumlingen, 2022-07-28



Jürgen Grün, Toimitusjohtaja Kemia & Laatu

Tämä suoritusasteoilmoitus on laadittu useilla kielillä. Jos tulkinnasta syntyy erimielisyyttä, englanninkielinen versio on aina katsottava ensisijaiseksi.

Lisäys sisältää vapaaehtoisesti ilmoitettua ja täydentävää englanninkielistä tietoa, joka ylittää (kielestä riippumatta määritellyt) lakisääteiset vaatimukset.

Translation guidance Essential Characteristics and Performance Parameters for Annexes

**Käännösopas oleellisten piirteiden ja suorituskyvyn parametrien liitteille**

Mechanical resistance and stability (BWR 1)

**Mekaaninen kestävyys ja vakaus (BWR 1)**

1	Characteristic resistance to steel failure of a single screw anchor under tension loading:  <b>Yksittäisen ankkurin kestävyys ilman teräsvauriota vetokuormituksen alaisena:</b>	$N_{Rk,s}$ [kN]
2	Characteristic resistance to steel failure of a single screw anchor under shear loading:  <b>Yksittäisen ruuviankkurin teräksen ominaisvastus leikkauskuormituksessa:</b>	$V_{Rk,s}$ [kN]; $M^0_{Rk,s}$ [Nm]
3	Characteristic resistance to pull-out failure or brick breakout failure of a single screw anchor under tension loading:  <b>Yksittäisen ankkurin kestävyys ulosvetovauriota tai tiilen irtoamista vastaan vetokuormituksen alaisena:</b>	$N_{Rk,p}$ ; $N_{Rk,b}$ ; $N_{Rk,p,c}$ ; $N_{Rk,b,c}$ [kN], $\alpha_{j,N}$ [-]
4	Characteristic resistance to local brick failure and brick edge failure of a single screw anchor under shear loading:  <b>Tyypillinen ominainen tiilen rikkoutumista tai yksittäisen ankkurin tiilen murtumisvauriota vastaan leikkauskuormituksen alaisena:</b>	$V_{Rk,b,II}$ ; $V_{Rk,b,\perp}$ ; $V_{Rk,c,II}$ ; $V_{Rk,c,\perp}$ [kN]; $\alpha_{f,VI}$ ; $\alpha_{j,V\perp}$ [-]
5	Characteristic resistance to brick breakout failure of a screw anchor group under tension loading:  <b>Usean ankkurin kestävyys tiilen murtumisvauriolla jännityskuormituksen alaisena:</b>	$N_{Rk}^g$ [kN]; $\alpha_{g,N}$ [-]
6	Characteristic resistance to local brick failure and brick edge failure of a screw anchors group under shear loading:  <b>Kestävyys tiilen murtumista tai ankkuriryhmän tiilen murtumisvauriota vastaan leikkauskuormituksen alaisena:</b>	$V^g_{Rk,b,II}$ ; $V^g_{Rk,b,\perp}$ ; $V^g_{Rk,c,II}$ ; $V^g_{Rk,c,\perp}$ [kN]; $\alpha_{g,VI}$ ; $\alpha_{g,VI\perp}$ [-]
7	Edge distances, joint distances, spacing, member thickness:  <b>Reuna etäisyydet, keskinäiset välit, osan paksuus:</b>	$c_{cr}$ ; $s_{cr,II}$ ; $s_{cr,\perp}$ ; $c_{min}$ ; $c_{j,II}$ ; $c_{j,\perp}$ ; $s_{min,II}$ ; $s_{min,\perp}$ ; $h_{min}$ [mm]
8	Resistance to combined tension and shear loading (hollow and perforated bricks):  <b>Yhdistetyn veto- ja leikkauskuormituksen kestävyys (ontto ja rei'itetty tiili):</b>	X [-]
9	Displacements: <b>Siirtymät:</b>	$\delta_{N0}$ ; $\delta_{N\infty}$ ; $\delta_{V0}$ ; $\delta_{V\infty}$ [mm]
Safety in case of fire (BWR 2)		
<b>Turvallisuus tulipalon sattuessa (BWR 2)</b>		
10	Reaction to fire: <b>Reaktio paloon:</b>	Class Luokka (A1)
11	Resistance to fire:  <b>Tulenkestävyys:</b>	$N_{Rk,s,fi}$ [kN]; $N_{Rk,p,fi}$ [kN]; $N_{Rk,b,fi}$ [kN]; $N^g_{Rk,fi}$ [kN]; $V_{Rk,s,fi}$ [kN]; $M^0_{Rk,s,fi}$ [Nm]; $c_{min,fi}$ ; $s_{min,fi}$ ; $c_{j,fi}$ [mm]
Other essential characteristics linked with the Basic Work Requirements		
<b>Muut työn perusvaatimuksiin liittyvät olennaiset ominaisuudet</b>		
12	Durability: <b>Kestävyys:</b>	-

## Specific Part

### 1 Technical description of the product

The Fischer concrete screw ULTRACUT FBS II is an anchor of sizes 6, 8 and 10 mm made of hardened carbon steel (FBS II, FBS II CP) or stainless steel with hardened tip (FBS II R). The anchor is screwed into a predrilled cylindrical drill hole. The special thread of the anchor cuts an internal thread into the member while setting. The anchorage is characterised by mechanical interlock in the special thread.

The product description is given in Annex A.

### 2 Specification of the intended use in accordance with the applicable European Assessment Document

The performances given in Section 3 are only valid if the anchor is used in compliance with the specifications and conditions given in Annex B.

The verifications and assessment methods on which this European Technical Assessment is based lead to the assumption of a working life of the anchors of at least 50 years. The indications given on the working life cannot be interpreted as a guarantee given by the producer, but are to be regarded only as a means for choosing the right products in relation to the expected economically reasonable working life of the works.

### 3 Performance of the product and references to the methods used for its assessment

#### 3.1 Mechanical resistance and stability (BWR 1)

Essential characteristic	Performance
Characteristic resistance to steel failure of a single screw anchor under tension loading	See Annex C 1
Characteristic resistance to steel failure of a single screw anchor under shear loading	See Annex C 1
Characteristic resistance to pull-out failure or brick breakout failure of a single screw anchor under tension loading	See Annex C 2 - C 12
Characteristic resistance to local brick failure and brick edge failure of a single screw anchor under shear loading	See Annex C 2 - C 12
Characteristic resistance to brick breakout failure of a screw anchor group under tension loading	See Annex C 2, C 5, C 8 and C 11
Characteristic resistance to local brick failure and brick edge failure of a screw anchor group under shear loading	See Annex C 2, C 5, C 8 and C 11
Edge distances, joint distances, spacing, member thickness	See Annex C 2, C 5, C 8 and C 11
Resistance to combined tension and shear loading (hollow and perforated bricks)	See Annex C 12
Displacements	See Annex C 3, C 6, C 9 and C 12

### 3.2 Safety in case of fire (BWR 2)

Essential characteristic	Performance
Reaction to fire	Class A 1
Resistance to fire	See Annex C 4, C 7 and C 10

### 4 Assessment and verification of constancy of performance (AVCP) system applied, with reference to its legal base

In accordance with the European Assessment Document EAD 330460-00-0604 the applicable European legal act is: 97/177/EC.

The system to be applied is: 1

## Installed conditions

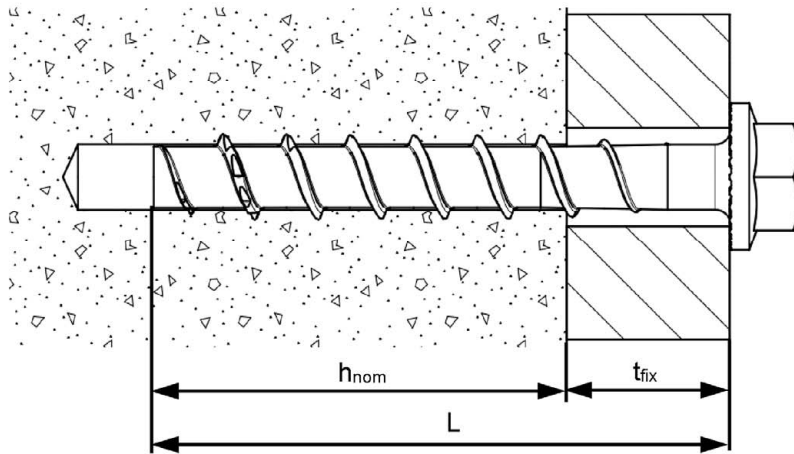

FBS II US in solid brick masonry

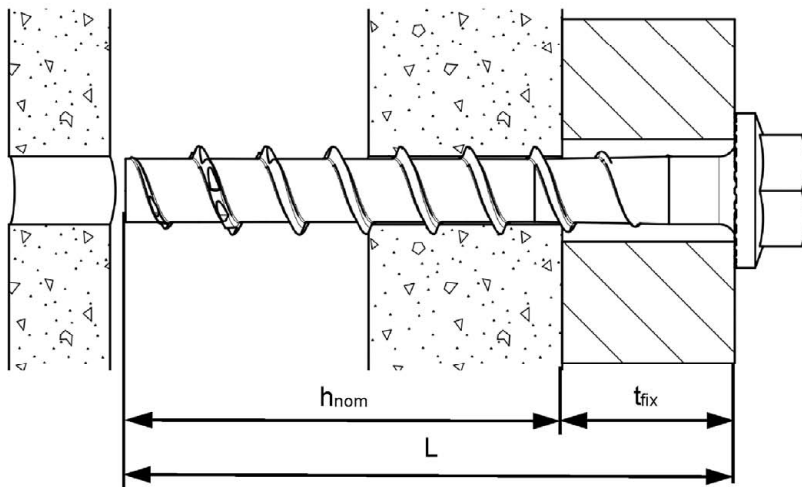

FBS II US in hollow brick masonry

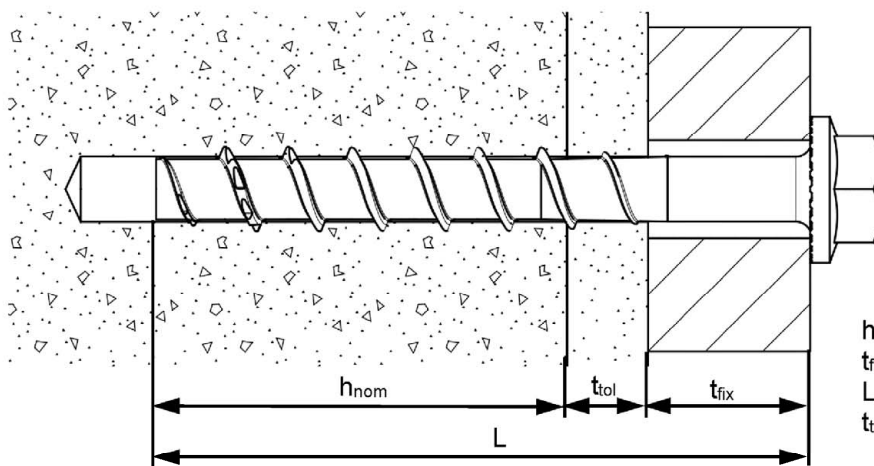

FBS II US with render bridge  
(solid brick masonry or hollow  
brick masonry)

$h_{nom}$  Nominal embedment depth  
 $t_{fix}$  Thickness of fixture  
 $L$  Screw length  
 $t_{tol}$  Thickness of unbearing layer











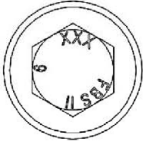
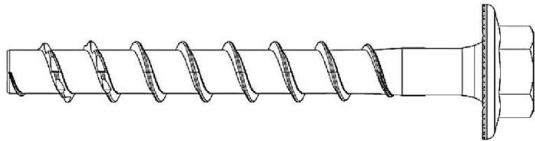

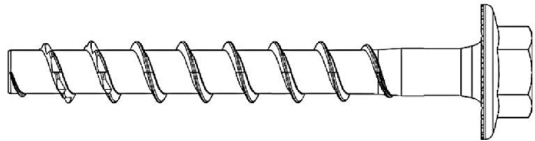

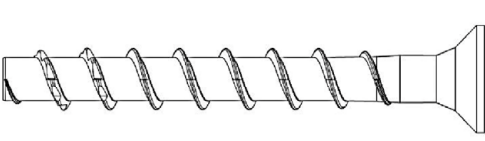

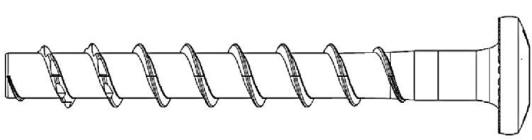
(Figures not to scale)

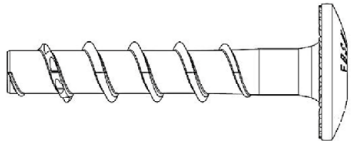
fischer concrete screw UltraCut FBS II, FBS II CP, FBS II R  
for anchorage in masonry

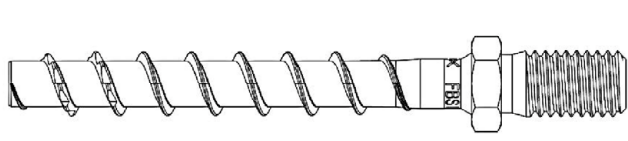
**Product description**  
Installed conditions

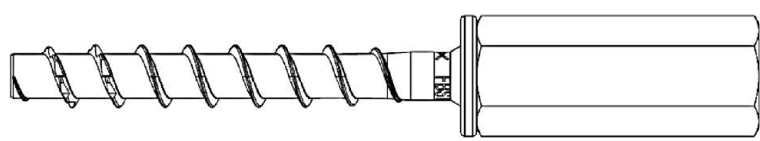
**Annex A 1**  
Appendix 3 / 25

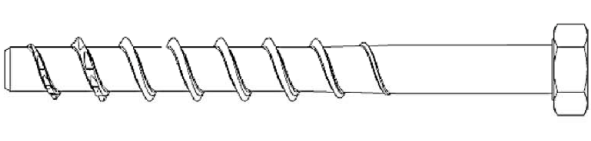
**Table A2.1: Screw types FBS II**

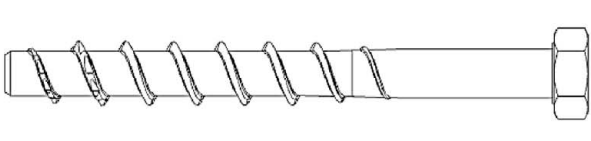
<p>Hexagon head with formed washer (US) Size 6-10</p>		
<p>Hexagon head with formed washer and TX-drive (US TX) Size 6-10</p>		
<p>Countersunk head (SK) Size 6-10</p>		
<p>Panhead (P) Size 6</p>		
<p>Large panhead (LP) Size 6</p>		
<p>Hexagon head and connection thread M8 or M10 (M) Size 6</p>		
<p>Hexagon connection nut with metric internal thread (I) Size 6</p>		
<p>Hexagon head (S) Size 8-10</p>		
<p>Hexagon head with TX-drive (S TX) Size 8-10</p>		

(Figures not to scale)

fischer concrete screw UltraCut FBS II, FBS II CP, FBS II R for anchorage in masonry

**Product description**  
Screw types

**Annex A 2**  
Appendix 4 / 25

**Table A3.1: Dimensions and material**

Screw types / size		All head shapes			
		6	8	10	
Thread outer diameter	$d_a$	[mm]	7,75	10,3	12,5
Core diameter	$d_k$		5,65	7,4(7,5 <sup>1)</sup> )	9,4
Shaft diameter	$d_s$		6,0	8,0	9,9
Material FBS II, FBS II CP		[-]	Hardened carbon steel; $A_5 \geq 8\%$		
Material FBS II R			-	Tip: Hardened stainless steel; Shaft and head: Stainless steel	
Coating FBS II			Galvanised		
Coating FBS II CP			-	Multi-layer coating	

<sup>1)</sup> Core diameter FBS II R

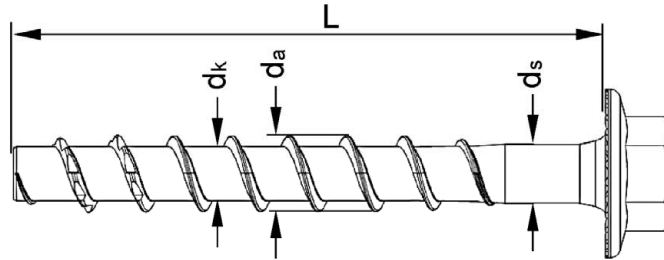

**Marking of screw types US, US TX, S, S TX, SK, P, LP**

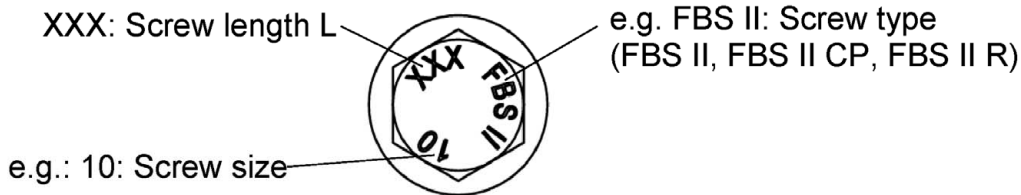

**Marking of screw types M8, M10, I**

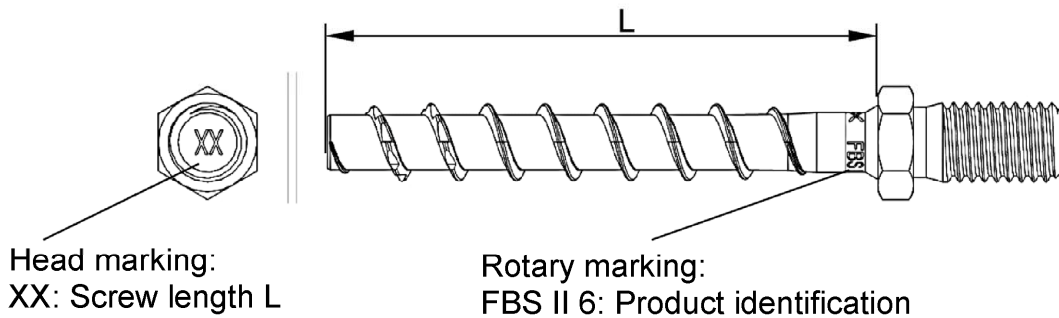

(Figures not to scale)

fischer concrete screw UltraCut FBS II, FBS II CP, FBS II R  
for anchorage in masonry

**Product description**  
Dimensions and marking

**Annex A 3**  
Appendix 5 / 25

## Specifications of intended use

### Anchorage subject to:

- Static and quasi-static actions in tension, shear or combined tension and shear or bending.
- Requirements related to resistance to fire (for dry masonry only)

### Base materials:

- Solid brick masonry see Annex C 2, C 5 and C 8
- Hollow brick masonry see Annex C 11
- Minimum thickness of masonry member in accordance with brick width (see Annex C 2, C 5, C 8 and C 11)
- Horizontal joints must be completely filled with mortar according to EN 998-2:2016 with strength class at minimum M2,5. Vertical Joints can, but do not have to be filled with mortar
- In case of fire, all joints must be completely filled with mortar according to EN 998-2:2016 with strength class at minimum M5.
- Dry and wet masonry

### Use conditions (Environmental conditions):

- **FBS II, FBS II CP, FBS II R:** Structures subject to dry internal conditions
- **FBS II R:** Conditions according to EN 1993-1-4:2006 + A1:2015 in accordance with Corrosion Resistance Class CRC III
- The covered temperature range of the masonry during the working life is within the range  $-40^{\circ}\text{C}$  to  $+80^{\circ}\text{C}$

fischer concrete screw UltraCut FBS II, FBS II CP, FBS II R  
for anchorage in masonry

**Intended use**  
Specifications

**Annex B 1**  
Appendix 6 / 25



**Design:**

- The anchorages have to be designed in accordance with EOTA Technical Report TR 054:2021-05, design method A under the responsibility of an engineer experienced in anchorage and masonry work.
- Screw size D6 and nominal embedment depth smaller than 50 mm may only be used for anchoring of statically indeterminate systems
- Verifiable calculation notes and drawings shall be prepared considering the relevant masonry in the area of anchorage, the loads to be transmitted and their transmission to the supports of the structure. The position of the anchor is indicated on the design drawings.
- The screw must be placed only in the wall side of the masonry.
- The characteristic resistance of the assessed solid bricks is also valid for larger brick sizes and higher mean compressive strength and higher dry density of the masonry unit.
- For the calculation of pull-out of a brick under tension load  $N_{Rk,pb}$  or pushing out a brick under shear load  $V_{Rk,pb}$  see EOTA Technical Report TR 054:2021-05.
- For joint widths  $w_j > 3$  mm, installation in the joint and close to the joint is not possible; the distances to joints  $c_j$  have to comply with Annex B 6.
- For joint widths  $w_j \leq 3$  mm, installation in the joint and close to the joint is possible, if the joint factors according to Annex C are considered. Horizontal joints must be completely filled with mortar, vertical joints can, but do not have to be filled with mortar.

**Installation:**

- Bridging of unbearing layer  $t_{tol}$  (e.g.: plaster) is possible but has to be considered for choosing the length of the screw.  $t_{tol}$  must be added to the length.  $L \geq h_{nom} + t_{tol} + t_{fix}$  (see figure Annex A1)
- During installation, the joint, spacing and edge distances specified by the planner must be considered. Installation in joints  $> 3$  mm is not allowed.
- Hole drilling by hammer drilling or rotary drilling, with standard hammer drill bits or hollow drill bits (in accordance with Annex C). The masonry must not be damaged during hammer drilling. If cracks occur during drilling, the rotary mode must be used. In this case the hole must be aborted.
- In case of aborted hole: The hole shall be filled with high strength mortar.
- Cleaning of the hole is not necessary if the driller is vented 3 times when reaching the correct drillhole depth (According B5), or when using a hollow drill with functional suction.
- Screw installation carried out by appropriately qualified personnel under the supervision of the person responsible for technical matters on site.

fischer concrete screw UltraCut FBS II, FBS II CP, FBS II R  
for anchorage in masonry

**Intended use**  
Design and Installation

**Annex B 2**  
Appendix 7 / 25

**Table B3.1: Installation parameters**

Size		FBS II		
		6	8	10
Nominal embedment depth	$h_{nom}$	$\geq 40$	$\geq 50$	$\geq 55$
Nominal drill hole diameter	$d_0$	6	8	10
Cutting diameter of drill bits	$d_{cut} \leq$	6,45	8,45	10,45
Clearance hole diameter	$d_f$	$\leq 8$	$\leq 12,0$	$\leq 14,0$
Wrench size (US, S, M, I)	SW	10/13	13	15
Tx size (US TX, SK, L, LP)	Tx	30	40	50
Countersunk head diameter	$d_h$	13,5	18	21
Drill hole depth	$h_1$	$\geq L - t_{fix} - t_{tol}^{(2)} + 10 \text{ mm}$		
Thickness of fixture	$t_{fix}$	$\leq L - h_{nom} - t_{tol}^{(2)}$		
Screw length	$L_{min} =$	40	50	55
	$L_{max} =$	325 (55 <sup>1)</sup> )	400	405

1) Screw type M and I

2) for Installation condition with render bridge see figure 3 in Annex A1

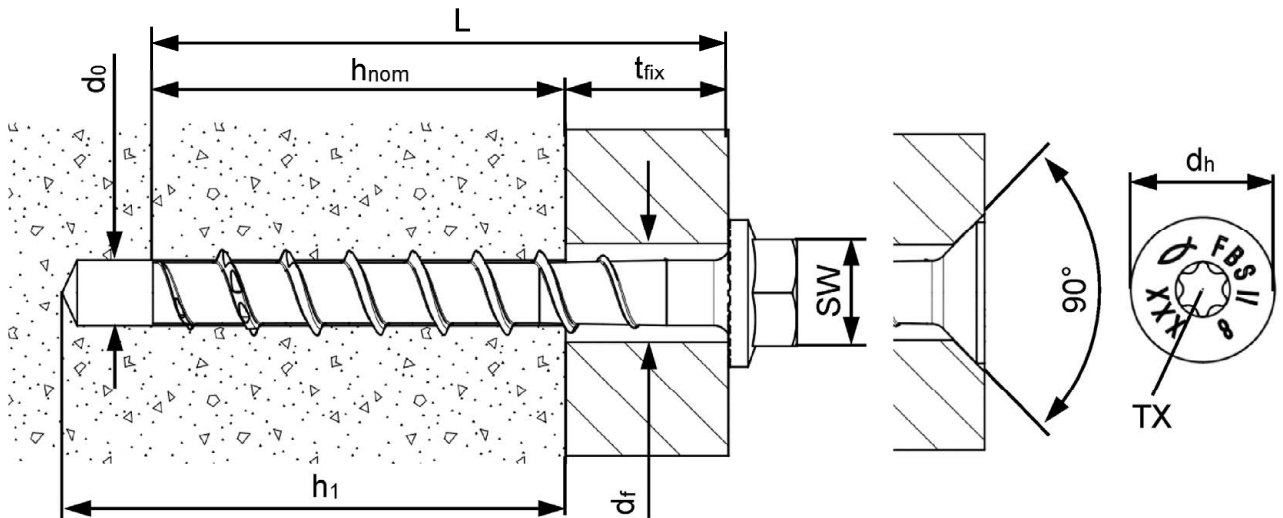

(Figures not to scale)

fischer concrete screw UltraCut FBS II, FBS II CP, FBS II R  
for anchorage in masonry

**Intended use**  
Installation parameters

**Annex B 3**  
Appendix 8 / 25

## Adjustment process

### Installed condition before adjustment

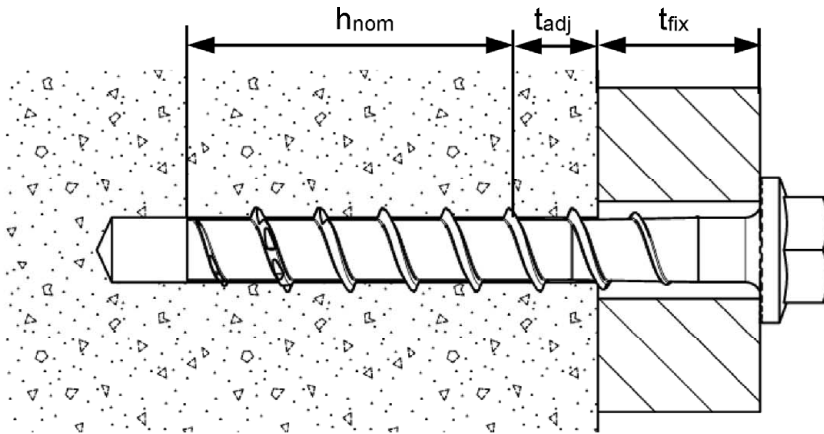

### Installed condition after adjustment

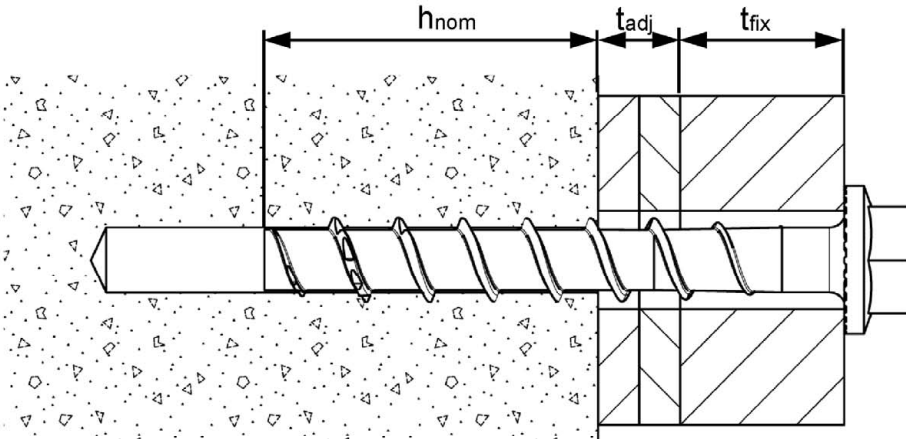

(Figures not to scale)

It is permissible to loosen the screw up to two times for adjustment.

For this purpose, the screw can be loosened up to a maximum of  $L_{adj} = 20$  mm from the surface of the initial fixture. The total permissible thickness of the relining inserted during the adjustment process is  $t_{adj} = 10$  mm.

The required nominal anchoring depth  $h_{nom}$  must be kept after the adjustment process.

fischer concrete screw UltraCut FBS II, FBS II CP, FBS II R  
for anchorage in masonry

**Intended use**  
Adjustment process

**Annex B 4**  
Appendix 9 / 25

## Installation instruction

### Step 1: Drill hole creation:

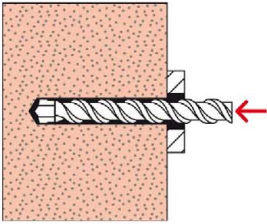

Drill the borehole using a standard hammer drill or a hollow drill. The joint, spacing and edge distances specified by the planner must be considered.

When using a standard hammer drill, after reaching the required drill hole depth, insert the drill bit at least 3 times to the bottom of the drill hole while the machine is running and pull it out of the drill hole again ("ventilate" the drill hole).

Drill hole diameter  $d_0$  and drill hole depth  $h_1$  according to Table B3.1.

Drilling method (hammer drilling / rotary drilling) according to specifications in Annex C.

### Step 2: Installation:

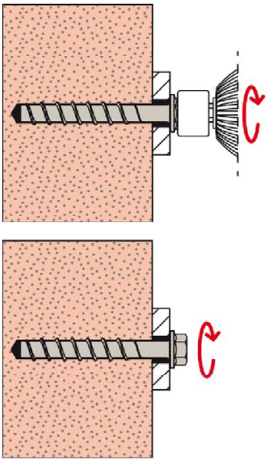

The screws may be installed using cordless screwdrivers, socket wrenches, screwdrivers and other standard screwdriving tools. The tightening torque applied after complete installation must not exceed the maximum installation torque (max  $T_{inst}$  according to Annex C).

Alternative: The screws may be installed with any tangential impact screw driver up to the maximum specified device torque  $T_{imp,max}$  as specified in Annex C.

Recommended tangential impact screw driver: FSS 18V 400 BL according to Annex B 8 at a suitable power level as specified in Annex C.

### Step 3: Check for correct installation:

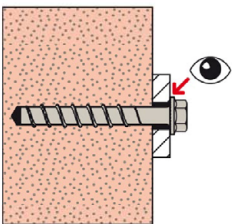

After installation further turning of the screw must not be possible. The maximum installation torque (max  $T_{inst}$  according to Annex C) must not be exceeded during checking.

The screw head must rest on the attachment part and must not be damaged.

### Adjustment:

Optional:

The screw may be adjusted according to Annex B 4.

In the case of adjustment, the screw may be unscrewed by a maximum of  $L_{adj} = 20\text{mm}$ .

The maximum shimming  $t_{adj} = 10\text{mm}$  must not be exceeded.

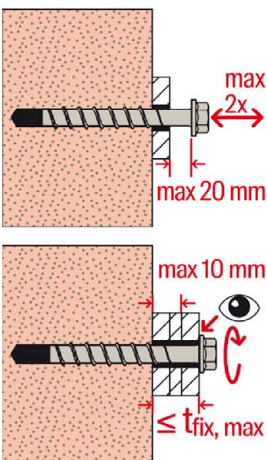

fischer concrete screw UltraCut FBS II, FBS II CP, FBS II R  
for anchorage in masonry

**Intended use**  
Installation instruction

**Annex B 5**  
Appendix 10 / 25

## Possible installation positions for joint width > 3 mm

For joint widths >3 mm, the distances  $c_J$  must be observed.

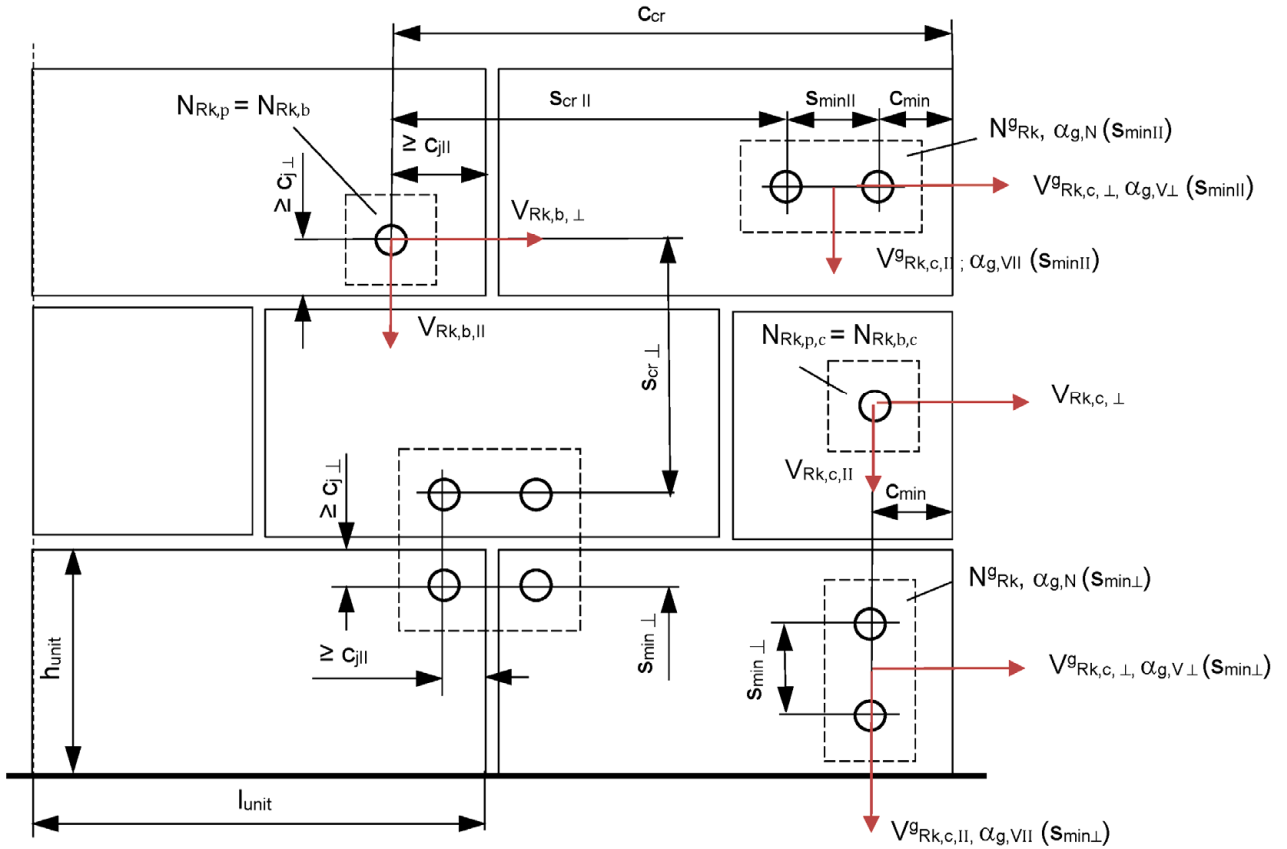

(Figures not to scale)

- $c_{min}$  = minimum edge distance to free edge of the wall
- $c_{jII}$  = distance to vertical joints without influence on resistance of the screw anchor
- $c_{j\perp}$  = distance to horizontal joints without influence on resistance of the screw anchor
- $s_{minII}$  = minimum spacing parallel to the horizontal joint
- $s_{min\perp}$  = minimum spacing perpendicular to the horizontal joint
- $c_{cr}$  = edge distance for ensuring the transmission of the charact. resistance of a single screw anchor
- $s_{crII}$  = characteristic spacing parallel to the horizontal joint
- $s_{cr\perp}$  = characteristic spacing perpendicular to the horizontal joint
- $l_{unit}$  = length of the masonry unit
- $h_{unit}$  = height of the masonry unit
- $\alpha_{g,N}$  = group factor under tension load ( $\alpha_{g,N} = \alpha_{g,N}(s_{minII}) = \alpha_{g,N}(s_{min\perp})$ )
- $\alpha_{g,VII}$  = group factor under shear load parallel to the edge ( $\alpha_{g,VII} = \alpha_{g,VII}(s_{minII}) = \alpha_{g,VII}(s_{min\perp})$ )
- $\alpha_{g,V\perp}$  = group factor under shear load perpendicular to the edge ( $\alpha_{g,V\perp} = \alpha_{g,V\perp}(s_{minII}) = \alpha_{g,V\perp}(s_{min\perp})$ )

$$N_{RK} = N_{RK,b} = N_{RK,p} = N_{RK,b,c} = N_{RK,p,c}$$

$$V_{RK,II} = V_{RK,b,II} = V_{RK,c,II}; \quad V_{RK,\perp} = V_{RK,b,\perp} = V_{RK,c,\perp}$$

$$\text{For } s \geq s_{cr}: \alpha_{g,N} = \alpha_{g,VII} = \alpha_{g,V\perp} = 2$$

For  $s_{min} \leq s < s_{cr}$ :  $\alpha_{g,N}$ ;  $\alpha_{g,VII}$ ;  $\alpha_{g,V\perp}$  according to installation parameter of brick in Annex C

$$N_{RK}^g = \alpha_{g,N} \cdot N_{RK} \quad (\text{Group of 2 anchors})$$

$$V_{RK,II}^g = \alpha_{g,VII} \cdot V_{RK,II}; \quad V_{RK,\perp}^g = \alpha_{g,V\perp} \cdot V_{RK,\perp} \quad (\text{Group of 2 anchors})$$

$$N_{RK}^g = \alpha_{g,N}^2 \cdot N_{RK} \quad (\text{Group of 4 anchors})$$

$$V_{RK,II}^g = \alpha_{g,VII}^2 \cdot V_{RK,II}; \quad V_{RK,\perp}^g = \alpha_{g,V\perp}^2 \cdot V_{RK,\perp} \quad (\text{Group of 4 anchors})$$

fischer concrete screw UltraCut FBS II, FBS II CP, FBS II R  
for anchorage in masonry

**Intended use**  
Possible installation positions for joint width > 3 mm

**Annex B 6**  
Appendix 11 / 25

## Possible installation positions for joint width $\leq 3$ mm

The joint factors on this page,  $\alpha_j$  in accordance with Annex C and the group factors of Annex B 6 must be taken into account.

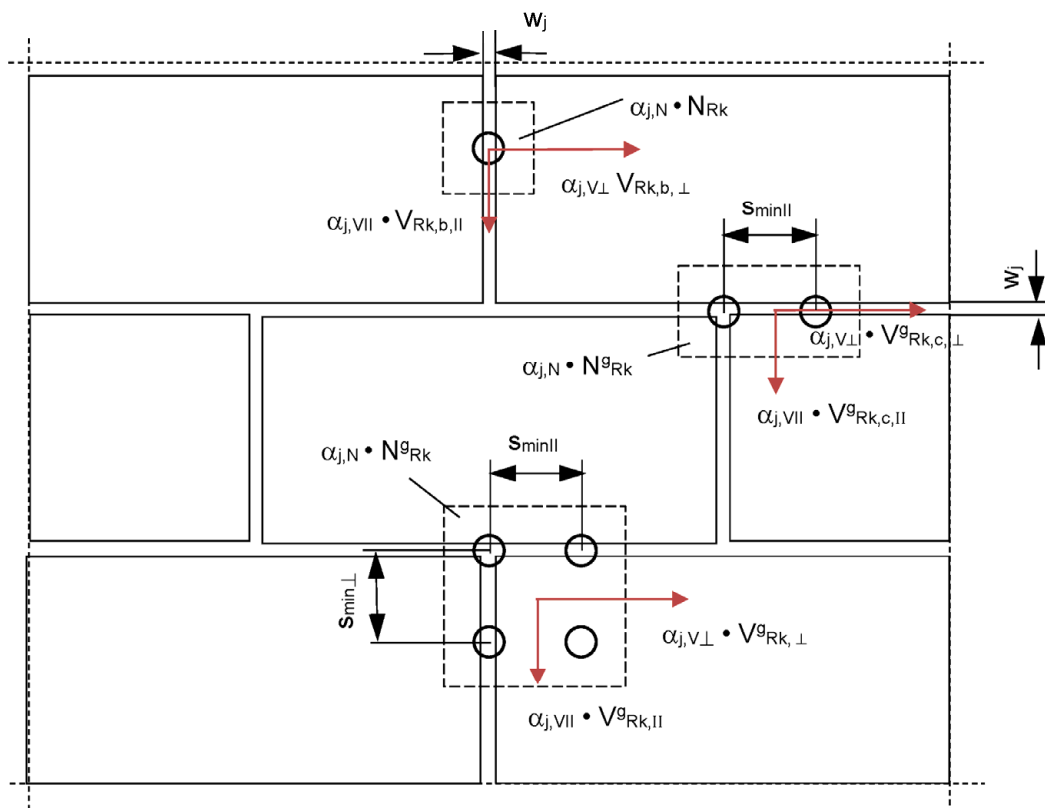

(Figures not to scale)

- $w_j$  = maximum permissible joint width for applications below  $c_{jII}$ ,  $c_{j⊥}$ ; the joint in which the screw is screwed in applies, in the case of cross joints, the less favorable applies
- $c_{jII}$  = distance to vertical joints without influence on resistance of the screw anchor
- $c_{j⊥}$  = distance to horizontal joints without influence on resistance of the screw anchor
- $\alpha_{j,N}$  = reduction factor under tension load for screw anchors influenced by joints
- $\alpha_{j,VII}$  = reduction factor under shear load parallel to the vertical joint for screw anchors influenced by joints
- $\alpha_{j,V⊥}$  = reduction factor under shear load perpendicular to the vertical joint for screw anchors influenced by joints

$$N_{RK} = N_{RK,b} = N_{RK,p} = N_{RK,b,c} = N_{RK,p,c}$$

$$V_{RK,II} = V_{RK,b,II} = V_{RK,c,II}; \quad V_{RK,⊥} = V_{RK,b,⊥} = V_{RK,c,⊥}$$

For setting positions with joint spacing  $c < c_{jII}$ ,  $c_{j⊥}$  and  $w_j \leq 3$  mm:

$$\begin{aligned} N^j_{RK} &= \alpha_{j,N} \cdot N_{RK} && \text{(Single anchor)} \\ V^j_{RK,II} &= \alpha_{j,VII} \cdot V_{RK,II}; \quad V^j_{RK,⊥} = \alpha_{j,V⊥} \cdot V_{RK,⊥} && \text{(Single anchor)} \\ N^g_{RK} &= \alpha_{j,N} \cdot N^g_{RK} && \text{(Group of anchors)} \\ V^g_{RK,II} &= \alpha_{j,VII} \cdot V^g_{RK,II}; \quad V^g_{RK,⊥} = \alpha_{j,V⊥} \cdot V^g_{RK,⊥} && \text{(Group of anchors)} \end{aligned}$$

fischer concrete screw UltraCut FBS II, FBS II CP, FBS II R  
for anchorage in masonry

**Intended use**  
Possible installation positions for joint width  $\leq 3$  mm

**Annex B 7**  
Appendix 12 / 25

## System equipment

Any tangential impact screw driver with maximum torque  $T_{imp, max}$  as specified for the respective brick according to Annex C.

e.g.: Cordless impact screw driver fischer FSS 18V 400 BL.



Setting of power level 1 to 12 of the fischer FSS 18V 400 BL as specified for the respective brick according to Annex C.

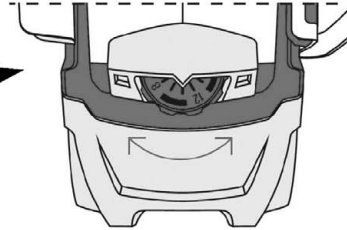

(Figures not to scale)

fischer concrete screw UltraCut FBS II, FBS II CP, FBS II R  
for anchorage in masonry

**Intended use**  
System equipment

**Annex B 8**  
Appendix 13 / 25

<b>Table C1.1: Characteristic resistance to steel failure of FBS II and FBS II CP</b>						
Size			FBS II		FBS II, FBS II CP	
			6	8	10	
<b>Characteristic resistance to steel failure under tension loading and shear loading</b>						
Characteristic resistance	$N_{Rk,s}$	[kN]	21	35	55	
Partial factor <sup>1)</sup>	$\gamma_{Ms,N}$	[-]	1,4			
Characteristic resistance	$V_{Rk,s}$	[kN]	9	13,1	29,4	
Partial factor <sup>1)</sup>	$\gamma_{Ms,V}$	[-]	1,5			
Characteristic bending resistance	$M^0_{Rk,s}$	[Nm]	17,1	51	95	

<b>Table C1.2: Characteristic resistance to steel failure of FBS II R</b>						
Size			FBS II R			
			6	8	10	
<b>Characteristic resistance to steel failure under tension loading and shear loading</b>						
Characteristic resistance	$N_{Rk,s}$	[kN]	No performance assessed	27,8	43,8	
Partial factor <sup>1)</sup>	$\gamma_{Ms,N}$	[-]		1,5		
Characteristic resistance	$V_{Rk,s}$	[kN]		18,0	13,2	
Partial factor <sup>1)</sup>	$\gamma_{Ms,V}$	[-]		1,25		
Characteristic bending resistance	$M^0_{Rk,s}$	[Nm]		31,3	68,5	

<b>Table C1.3: Specifications for the adjustment of FBS II, FBS II CP, FBS II R</b>						
Size			FBS II		FBS II, FBS II CP, FBS II R	
			6	8	10	
<b>Adjustment</b>						
Max. thickness of the relining	$t_{adj}$	[mm]	10			
Max. number of adjustments	$n_a$	[-]	2			

<sup>1)</sup> In absence of other national regulations

fischer concrete screw UltraCut FBS II, FBS II CP, FBS II R for anchoring in the masonry	<b>Annex C 1</b> Appendix 14 / 25
<b>Performances</b> Characteristic resistance to steel failure of a single anchor under tension / shear loading, Specifications for adjustment	



## Solid brick Mz, NF, EN 771-1:2011+A1:2015

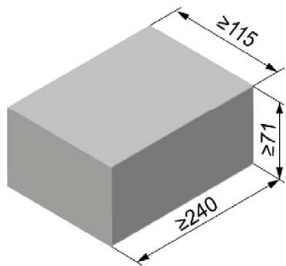

Solid brick Mz, NF, EN 771-1:2011+A1:2015			
Producer	e.g.: Wienerberger		
Nominal dimensions [mm]	length L	width B	height H
	≥ 240	≥ 115	≥ 71
Mean gross dry density $\rho$ [kg/dm <sup>3</sup> ]	≥ 1,8		
Mean compressive strength/ Min. compressive strength single brick <sup>1)</sup> [N/mm <sup>2</sup> ]	≥ 15/12		
Standard	EN 771-1:2011+A1:2015		

<sup>1)</sup> The compressive strength of the single brick must not be less than 80% of the mean compressive strength

**Table C2.1:** Installation parameters

Size			6	8	10
<b>General Installation parameters</b>					
Nominal embedment depth	$h_{nom}$	[mm]	≥ 40	≥ 50	≥ 55
Effective embedment depth	$h_{ef}$		≥ 32	≥ 40	≥ 43
Maximum installation torque	$\max T_{inst}$	[Nm]	10	20	20
Torque impact screw driver	$T_{imp,max}$		80	80	80
fischer impact screw driver FSS 18V 400 BL level		[-]	level 1	level 1	level 1
<b>Edge distance and spacing</b>					
Minimum edge distance to free edge	$C_{min}$	[mm]	50	60	70
Minimum spacing	$S_{min II} = S_{min \perp}$		80	80	80
Characteristic spacing	$C_{cr}$		1,5 $h_{nom}$		
	$S_{cr II} = S_{cr \perp}$		3 $h_{nom}$		
<b>Drilling mode</b>					
Edge distance ≥ 1,5 $h_{nom}$ Hammer drilling or rotary drilling with standard hammer drill bit or hollow drill bit					
Edge distance < 1,5 $h_{nom}$ Rotary drilling only with standard hammer drill bit or hollow drill bit					

**Table C2.2:** Group factors

Size			6	8	10
Group factor	$\alpha_{g,N}$	[-]	2,0	2,0	2,0
	$\alpha_{g,V II} = \alpha_{g,V \perp}$		1,75	1,75	1,75

**Table C2.3:** Reduction factors depending on the distance to joints and the joint width

Size			6	8	10	6	8	10
Maximum joint width	$w_j$	[mm]	> 3			≤ 3		
Distance to joints	$C_{j \perp}$	[mm]	≥ 10			≥ 10		
	$C_{j II}$		≥ 40			≥ 40		
Joint factor	$\alpha_{j,N}$	[-]	1 (full resistance)			1 (full resistance)		
	$\alpha_{j,V II} = \alpha_{j,V \perp}$							
Distance to joints	$C_{j \perp}$	[mm]	< 10			< 10		
	$C_{j II}$		< 40			< 40		
Joint factor	$\alpha_{j,N}$	[-]	0 (Screw must not be used)			0,5	0,5	0,5
	$\alpha_{j,V II} = \alpha_{j,V \perp}$					0,3	0,3	0,3

fischer concrete screw UltraCut FBS II, FBS II CP, FBS II R  
for anchoring in the masonry

**Performance**  
Solid brick Mz NF, dimensions, installation parameters, distances,  
group and joint factors

**Annex C 2**  
Appendix 15 / 25

## Solid brick Mz, NF, EN 771-1:2011+A1:2015

**Table C3.1:** Characteristic resistance to pull-out failure or brick breakout failure of a single anchor under tension loading

Size	6	8	10	
<b>Characteristic tension resistance depending on the mean compressive strength of the brick</b>				
Mean compressive strength/ Min. compressive strength single brick <sup>1)</sup> [N/mm <sup>2</sup> ]	Use category	$N_{RK} = N_{RK,p} = N_{RK,b} = N_{RK,p,c} = N_{RK,b,c}$ [kN]		
≥ 15/12	wet	1,3	1,1	1,1
	dry	1,9	1,6	1,4
≥ 20/16	wet	1,6	1,3	1,3
	dry	2,1	1,9	1,6
≥ 22/17,5	wet	1,6	1,3	1,4
	dry	2,3	2,0	1,7

<sup>1)</sup> The compressive strength of the single brick must not be less than 80% of the mean compressive strength.

**Table C3.2:** Characteristic resistance to local brick failure or brick edge failure of a single anchor under shear loading

Size	6	8	10				
<b>Characteristic shear resistance depending on the mean compressive strength of the brick</b>							
Mean compressive strength/ Min. compressive strength single brick <sup>1)</sup> [N/mm <sup>2</sup> ]	Use category	$V_{RK,  }$ [kN]	$V_{RK,⊥}$ [kN]	$V_{RK,  }$ [kN]	$V_{RK,⊥}$ [kN]	$V_{RK,  }$ [kN]	$V_{RK,⊥}$ [kN]
≥ 15/12	wet or dry	1,2	0,8	4,8	1,4	4,4	2,5
≥ 20/16	wet or dry	1,4	1,0	5,6	1,7	5,1	2,9
≥ 22/17,5	wet or dry	1,4	1,0	5,8	1,7	5,3	3,0

<sup>1)</sup> The compressive strength of the single brick must not be less than 80% of the mean compressive strength.

**Table C3.3:** Displacements under tension and shear loads

Size		6	8	10
Displacement-factor under tension load	$\delta_{N0}$ -Factor	0,1	0,15	0,2
	$\delta_{N\infty}$ -Factor	0,2	0,3	0,4
Displacement-factor under shear load	$\delta_{V0}$ -Factor	3,0	1,0	1,0
	$\delta_{V\infty}$ -Factor	4,5	1,5	1,5

Calculation of effective displacement:

$$\delta_{N0} = \delta_{N0}\text{-Factor} \times N \text{ [mm]}$$

$$\delta_{N\infty} = \delta_{N\infty}\text{-Factor} \times N \text{ [mm]}$$

N = Acting tension load

$$\delta_{V0} = \delta_{V0}\text{-Factor} \times V \text{ [mm]}$$

$$\delta_{V\infty} = \delta_{V\infty}\text{-Factor} \times V \text{ [mm]}$$

V = Acting shear load

fischer concrete screw UltraCut FBS II, FBS II CP, FBS II R  
for anchoring in the masonry

### Performance

Solid brick Mz NF, characteristic resistance under tension and shear loading, displacements

### Annex C 3

Appendix 16 / 25

# Solid brick Mz, NF, EN 771-1:2011+A1:2015

## Table C4.1: Characteristic resistance of a single anchor under fire exposure

Size	6		8		10	
<b>Characteristic resistance to steel failure under tension loading and shear loading under fire exposure</b>						
$N_{Rk,s,fi} = V_{Rk,s,fi}$	[kN]	R30	0,6	1,1	1,8	
		R60	0,5	0,9	1,5	
		R90	0,4	0,7	1,1	
		R120	0,3	0,5	1,0	
<b>Characteristic Bending moment under fire exposure <math>M^0_{Rk,s,fi}</math></b>						
$M^0_{Rk,s,fi}$	[Nm]	R30	0,6	1,5	3,1	
		R60	0,5	1,2	2,6	
		R90	0,4	1,0	2,0	
		R120	0,3	0,8	1,7	
<b>Characteristic resistance to pull-out failure and local brick failure under fire exposure</b>						
Mean compressive strength/ Min. compressive strength single brick <sup>1)</sup>	[N/mm <sup>2</sup> ]		≥ 15/12			
$N_{Rk,b,fi} = N_{Rk,p,fi}$	[kN]	R30	1,3			
		R60	1,2			
		R90	1,1			
		R120	1,0			
Min. edge distance	[mm]	$C_{min,fi}$	$2 \times h_{nom}$			
Characteristic edge distance and spacing		$C_{cr,fi}$	$2 \times h_{nom}$			
		$S_{cr,fi}$	$4 \times h_{nom}$			
Distance to joints		$C_{j \perp,fi}$	≥ 35			
		$C_{j \parallel,fi}$	≥ 40			

<sup>1)</sup> The compressive strength of the single brick must not be less than 80% of the mean compressive strength.

## Table C4.2: Characteristic resistance of groups under fire exposure

Size	6		8		10	
<b>Characteristic resistance to pull-out failure and local brick failure of groups under fire exposure</b>						
$N^g_{Rk,fi} = N^g_{Rk,b,fi} = N^g_{Rk,p,fi}$	[kN]	R30-R90	$0,11 \times N^g_{Rk,b}$	$0,14 \times N^g_{Rk,b}$	$0,15 \times N^g_{Rk,b}$	
		R120	$0,09 \times N^g_{Rk,b}$	$0,11 \times N^g_{Rk,b}$	$0,12 \times N^g_{Rk,b}$	
Min. edge distance and spacing	[mm]	$C_{min,fi}$	$2 \times h_{nom}$			
		$S_{min,fi}$	107			

Application in the joint or near the joint according to Table C2.3, is not permitted under fire exposure.

fischer concrete screw UltraCut FBS II, FBS II CP, FBS II R  
for anchoring in the masonry

### Performance

Solid brick Mz NF, characteristic resistance under fire exposure

### Annex C 4

Appendix 17 / 25

## Solid brick Mz, nordic, EN 771-1:2011+A1:2015

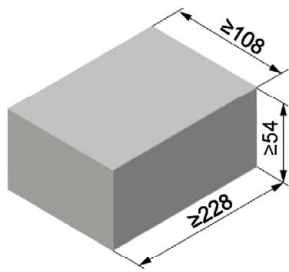

Solid brick Mz, nordic, EN 771-1:2011+A1:2015			
Producer	e.g.: Wienerberger		
Nominal dimensions [mm]	length L	width B	height H
	≥ 228	≥ 108	≥ 54
Mean gross dry density $\rho$ [kg/dm <sup>3</sup> ]	≥ 1,8		
Mean compressive strength/ Min. compressive strength single brick <sup>1)</sup> [N/mm <sup>2</sup> ]	≥ 20/16		
Standard	<b>EN 771-1:2011+A1:2015</b>		

<sup>1)</sup> The compressive strength of the single brick must not be less than 80% of the mean compressive strength

**Table C5.1:** Installation parameters

Size		6	8	10	
<b>General Installation parameters</b>					
Nominal embedment depth	$h_{nom}$	[mm]	≥ 40	≥ 50	≥ 55
Effective embedment depth	$h_{ef}$		≥ 32	≥ 40	≥ 43
Maximum installation torque	$\max T_{inst}$	[Nm]	10	20	20
Torque impact screw driver	$T_{imp,max}$		80	80	80
fischer impact screw driver FSS 18V 400 BL level		[-]	level 1	level 1	level 1
<b>Edge distance and spacing</b>					
Minimum edge distance to free edge	$C_{min}$	[mm]	50	60	70
Minimum spacing	$S_{min II} = S_{min \perp}$		80	80	80
Characteristic spacing	$C_{cr}$		1,5 $h_{nom}$		
	$S_{cr II} = S_{cr \perp}$	3 $h_{nom}$			
<b>Drilling mode</b>					
Hammer drilling or rotary drilling with standard hammer drill bit or hollow drill bit					
Rotary drilling only with standard hammer drill bit or hollow drill bit for edge distance < 1,5 $h_{nom}$					

**Table C5.2:** Group factors

Size		6	8	10	
Group factor	$\frac{\alpha_{g,N}}{\alpha_{g,V II} = \alpha_{g,V \perp}}$	[-]	2,0	2,0	2,0
			1,75	1,75	1,75

**Table C5.3:** Reduction factors depending on the distance to joints and the joint width

Size		6	8	10	6	8	10
Maximum joint width	$w_j$	[mm]					
		> 3			≤ 3		
Distance to joints	$C_{j \perp}$	[mm]					
	$C_{j II}$	≥ 10			≥ 10		
Joint factor	$\frac{\alpha_{j,N}}{\alpha_{j,V II} = \alpha_{j,V \perp}}$	[-]					
		1 (full resistance)			1 (full resistance)		
Distance to joints	$C_{j \perp}$	[mm]					
	$C_{j II}$	< 10			< 10		
Joint factor	$\frac{\alpha_{j,N}}{\alpha_{j,V II} = \alpha_{j,V \perp}}$	[-]					
		0 (Screw must not be used)			0,5	0,5	0,5
					0,3	0,3	0,3

fischer concrete screw UltraCut FBS II, FBS II CP, FBS II R for anchoring in the masonry

### Performance

Solid brick Mz nordic, dimensions, installation parameters, distances, group and joint factors

## Annex C 5

Appendix 18 / 25

## Solid brick Mz, nordic, EN 771-1:2011+A1:2015

**Table C6.1:** Characteristic resistance to pull-out failure or brick breakout failure of a single anchor under tension loading

Size		6	8	10
<b>Characteristic Tension resistance depending on the mean compressive strength of the brick</b>				
Mean compressive strength/ Min. compressive strength single brick <sup>1)</sup> [N/mm <sup>2</sup> ]	Use category	$N_{RK} = N_{RK,p} = N_{RK,b} = N_{RK,p,c} = N_{RK,b,c}$ [kN]		
≥ 20/16	wet	0,9	1,1	1,1
	dry	1,2	1,6	1,3
≥ 25/20	wet	1,0	1,2	1,2
	dry	1,4	1,8	1,5
≥ 28/22,5	wet	1,0	1,3	1,3
	dry	1,4	1,9	1,6

<sup>1)</sup> The compressive strength of the single brick must not be less than 80% of the mean compressive strength.

**Table C6.2:** Characteristic resistance to local brick failure or brick edge failure of a single anchor under shear loading

Size		6	8	10			
<b>Characteristic shear resistance depending on the mean compressive strength of the brick</b>							
Mean compressive strength/ Min. compressive strength single brick <sup>1)</sup> [N/mm <sup>2</sup> ]	Use category	$V_{RK,  }$ [kN]	$V_{RK,⊥}$ [kN]	$V_{RK,  }$ [kN]	$V_{RK,⊥}$ [kN]	$V_{RK,  }$ [kN]	$V_{RK,⊥}$ [kN]
≥ 20/16	wet or dry	1,1	0,8	4,7	1,4	4,3	2,4
≥ 25/20	wet or dry	1,3	0,9	5,2	1,6	4,8	2,7
≥ 28/22,5	wet or dry	1,4	1,0	5,6	1,7	5,1	2,9

<sup>1)</sup> The compressive strength of the single brick must not be less than 80% of the mean compressive strength.

**Table C6.3:** Displacements under tension and shear loads

Size			6	8	10
Displacement-factor under tension load	$\delta_{N0}$ -Factor	[mm/kN]	0,1	0,15	0,2
	$\delta_{N\infty}$ -Factor		0,2	0,3	0,4
Displacement-factor under shear load	$\delta_{V0}$ -Factor		1,0	0,75	0,5
	$\delta_{V\infty}$ -Factor		1,5	1,13	0,75

Calculation of effective displacement:

$$\delta_{N0} = \delta_{N0}\text{-Factor} \times N \text{ [mm]}$$

$$\delta_{N\infty} = \delta_{N\infty}\text{-Factor} \times N \text{ [mm]}$$

N = Acting tension load

$$\delta_{V0} = \delta_{V0}\text{-Factor} \times V \text{ [mm]}$$

$$\delta_{V\infty} = \delta_{V\infty}\text{-Factor} \times V \text{ [mm]}$$

V = Acting shear load

fischer concrete screw UltraCut FBS II, FBS II CP, FBS II R  
for anchoring in the masonry

### Performance

Solid brick Mz nordic, characteristic resistance under tension and shear loading, displacements

### Annex C 6

Appendix 19 / 25

# Solid brick Mz, nordic, EN 771-1:2011+A1:2015

## Table C7.1: Characteristic resistance of a single anchor under fire exposure

Size	6		8		10	
<b>Characteristic resistance to steel failure under tension loading and shear loading under fire exposure</b>						
$N_{Rk,s,fi} = V_{Rk,s,fi}$	[kN]	R30	0,6	1,1	1,8	
		R60	0,5	0,9	1,5	
		R90	0,4	0,7	1,1	
		R120	0,3	0,5	1,0	
<b>Characteristic Bending moment under fire exposure <math>M^0_{Rk,s,fi}</math></b>						
$M^0_{Rk,s,fi}$	[Nm]	R30	0,6	1,5	3,1	
		R60	0,5	1,2	2,6	
		R90	0,4	1,0	2,0	
		R120	0,3	0,8	1,7	
<b>Characteristic resistance to pull-out failure and local brick failure under fire exposure <sup>2)</sup></b>						
Mean compressive strength/ Min. compressive strength single brick <sup>1)</sup>	[N/mm <sup>2</sup> ]		≥ 20/16			
$N_{Rk,b,fi} = N_{Rk,p,fi}$	[kN]	R30	1,3			
		R60	1,2			
		R90	1,1			
		R120	1,0			
Min. edge distance	[mm]	$C_{min,fi}$	$2 \times h_{nom}$			
Characteristic edge distance and spacing		$C_{cr,fi}$	$2 \times h_{nom}$			
		$S_{cr,fi}$	$4 \times h_{nom}$			
Distance to joints		$C_{j \perp,fi}$	≥ 35			
		$C_{j \parallel,fi}$	≥ 40			

<sup>1)</sup> The compressive strength of the single brick must not be less than 80% of the mean compressive strength.

<sup>2)</sup> Only applicable for brick heights  $H \geq 70$

## Table C7.2: Characteristic resistance of groups under fire exposure

Size	6		8		10	
<b>Characteristic resistance to pull-out failure and local brick failure of groups under fire exposure</b>						
$N^g_{Rk,fi} = N^g_{Rk,b,fi} = N^g_{Rk,p,fi}$	[kN]	R30-R90	$0,11 \times N^g_{Rk,b}$	$0,14 \times N^g_{Rk,b}$	$0,15 \times N^g_{Rk,b}$	
		R120	$0,09 \times N^g_{Rk,b}$	$0,11 \times N^g_{Rk,b}$	$0,12 \times N^g_{Rk,b}$	
Min. edge distance and spacing	[mm]	$C_{min,fi}$	$2 \times h_{nom}$			
		$S_{min,fi}$	107			

Application in the joint or near the joint according to Table C5.3, is not permitted under fire exposure.

fischer concrete screw UltraCut FBS II, FBS II CP, FBS II R  
for anchoring in the masonry

### Performance

Solid brick Mz nordic, characteristic resistance under fire exposure

### Annex C 7

Appendix 20 / 25

# Solid brick KS, NF, EN 771-2:2011+A1:2015

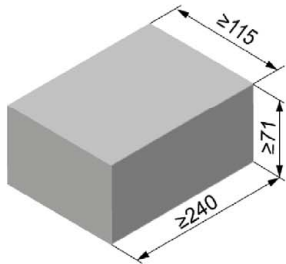

## Solid brick Mz, NF, EN 771-2:2011+A1:2015

Producer	e.g.: KS Wemding		
Nominal dimensions [mm]	length L	width B	height H
	≥ 240	≥ 115	≥ 71
Mean gross dry density $\rho$ [kg/dm <sup>3</sup> ]	≥ 1,8		
Mean compressive strength/ Min. compressive strength single brick <sup>1)</sup> [N/mm <sup>2</sup> ]	≥ 15/12		
Standard	<b>EN 771-2:2011+A1:2015</b>		

<sup>1)</sup> The compressive strength of the single brick must not be less than 80% of the mean compressive strength

**Table C8.1:** Installation parameters

Size			6	8	10
<b>General Installation parameters</b>					
Nominal embedment depth	$h_{nom}$	[mm]	≥ 40	≥ 50	≥ 55
Effective embedment depth	$h_{ef}$		≥ 32	≥ 40	≥ 43
Maximum installation torque	$\max T_{inst}$	[Nm]	10	20	20
Torque impact screw driver	$T_{imp,max}$		80	80	80
fischer impact screw driver FSS 18V 400 BL level		[-]	level 1	level 1	level 1
<b>Edge distance and spacing</b>					
Minimum edge distance to free edge	$c_{min}$	[mm]	50	60	70
Minimum spacing	$s_{min II} = s_{min \perp}$		80	80	80
Characteristic spacing	$c_{cr}$		1,5 $h_{nom}$		
	$s_{cr II} = s_{cr \perp}$		3 $h_{nom}$		
<b>Drilling mode</b>					
Hammer drilling or rotary drilling with standard hammer drill bit or hollow drill bit					

**Table C8.2:** Group factors

Size			6	8	10
Group factor	$\alpha_{g,N}$	[-]	1,75	1,75	1,75
	$\alpha_{g,V II} = \alpha_{g,V \perp}$		1,85	1,85	1,85

**Table C8.3:** Reduction factors depending on the distance to joints and the joint width

Size			6	8	10	6	8	10
Maximum joint width	$w_j$	[mm]	> 3			≤ 3		
Distance to joints	$c_{j \perp}$	[mm]	≥ 10			≥ 10		
	$c_{j II}$		≥ 40			≥ 40		
Joint factor	$\frac{\alpha_{j,N}}{\alpha_{j,V II} = \alpha_{j,V \perp}}$	[-]	1 (full resistance)			1 (full resistance)		
Distance to joints	$c_{j \perp}$	[mm]	< 10			< 10		
	$c_{j II}$		< 40			< 40		
Joint factor	$\frac{\alpha_{j,N}}{\alpha_{j,V II} = \alpha_{j,V \perp}}$	[-]	0 (Screw must not be used)			0,7		

fischer concrete screw UltraCut FBS II, FBS II CP, FBS II R for anchoring in the masonry

### Performance

Solid brick KS NF, dimensions, installation parameters, distances, group and joint factors

## Annex C 8

Appendix 21 / 25

## Solid brick KS, NF, EN 771-2:2011+A1:2015

**Table C9.1:** Characteristic resistance to pull-out failure or brick breakout failure of a single anchor under tension loading

Size	6	8	10	
<b>Characteristic Tension resistance depending on the mean compressive strength of the brick</b>				
Mean compressive strength/ Min. compressive strength single brick <sup>1)</sup> [N/mm <sup>2</sup> ]	Use category	$N_{RK} = N_{RK,p} = N_{RK,b} = N_{RK,p,c} = N_{RK,b,c}$ [kN]		
≥ 15/12	wet	1,3	1,8	1,9
	dry	1,5	1,9	1,9
≥ 20/16	wet	1,4	2,0	2,1
	dry	1,7	2,1	2,2
≥ 25/20	wet	1,6	2,2	2,3
	dry	1,9	2,4	2,4
≥ 28/22,5	wet	1,7	2,3	2,5
	dry	2,0	2,5	2,6

<sup>1)</sup> The compressive strength of the single brick must not be less than 80% of the mean compressive strength.

**Table C9.2:** Characteristic resistance to local brick failure or brick edge failure of a single anchor under shear loading

Size	6	8	10				
<b>Characteristic shear resistance depending on the mean compressive strength of the brick</b>							
Mean compressive strength/ Min. compressive strength single brick <sup>1)</sup> [N/mm <sup>2</sup> ]	Use category	$V_{RK,  }$ [kN]	$V_{RK,⊥}$ [kN]	$V_{RK,  }$ [kN]	$V_{RK,⊥}$ [kN]	$V_{RK,  }$ [kN]	$V_{RK,⊥}$ [kN]
≥ 15/12	wet or dry	1,8	0,8	2,3	1,5	3,1	1,0
≥ 20/16	wet or dry	2,1	0,9	2,6	1,7	3,5	1,2
≥ 25/20	wet or dry	2,3	1,0	2,9	1,9	3,9	1,3
≥ 28/22,5	wet or dry	2,4	1,0	3,0	2,0	4,1	1,4

<sup>1)</sup> The compressive strength of the single brick must not be less than 80% of the mean compressive strength.

**Table C9.3:** Displacements under tension and shear loads

Size	6	8	10	
Displacement-factor under tension load	$\delta_{N0}$ -Factor	0,2	0,2	0,15
	$\delta_{N\infty}$ -Factor	0,4	0,4	0,3
Displacement-factor under shear load	$\delta_{V0}$ -Factor	4,5	2,0	1,25
	$\delta_{V\infty}$ -Factor	6,75	3,0	1,88

Calculation of effective displacement:

$$\delta_{N0} = \delta_{N0}\text{-Factor} \times N \text{ [mm]}$$

$$\delta_{N\infty} = \delta_{N\infty}\text{-Factor} \times N \text{ [mm]}$$

N = Acting tension load

$$\delta_{V0} = \delta_{V0}\text{-Factor} \times V \text{ [mm]}$$

$$\delta_{V\infty} = \delta_{V\infty}\text{-Factor} \times V \text{ [mm]}$$

V = Acting shear load

fischer concrete screw UltraCut FBS II, FBS II CP, FBS II R  
for anchoring in the masonry

### Performance

Solid brick KS NF, characteristic resistance under tension and shear loading, displacements

## Annex C 9

Appendix 22 / 25



**Solid brick KS, NF, EN 771-2:2011+A1:2015**
**Table C10.1: Characteristic resistance of a single anchor under fire exposure**

Size		6	8	10	
<b>Characteristic resistance to steel failure under tension loading and shear loading under fire exposure</b>					
$N_{Rk,s,fi} = V_{Rk,s,fi}$	[kN]	R30	0,6	1,1	1,8
		R60	0,5	0,9	1,5
		R90	0,4	0,7	1,1
		R120	0,3	0,5	1,0
<b>Characteristic Bending moment under fire exposure <math>M^0_{Rk,s,fi}</math></b>					
$M^0_{Rk,s,fi}$	[Nm]	R30	0,6	1,5	3,1
		R60	0,5	1,2	2,6
		R90	0,4	1,0	2,0
		R120	0,3	0,8	1,7
<b>Characteristic resistance to pull-out failure and local brick failure under fire exposure</b>					
Mean compressive strength/ Min. compressive strength single brick <sup>1)</sup>	[N/mm <sup>2</sup> ]		≥ 15/12		
$N_{Rk,b,fi} = N_{Rk,p,fi}$	[kN]	R30	1,3		
		R60	1,2		
		R90	1,1		
		R120	1,0		
Min. edge distance	[mm]	$C_{min,fi}$	$2 \times h_{nom}$		
Characteristic edge distance and spacing		$C_{cr,fi}$	$2 \times h_{nom}$		
		$S_{cr,fi}$	$4 \times h_{nom}$		
Distance to joints		$C_{j \perp,fi}$	≥ 35		
	$C_{j \parallel,fi}$	≥ 40			

<sup>1)</sup> The compressive strength of the single brick must not be less than 80% of the mean compressive strength.

**Table C10.2: Characteristic resistance of groups under fire exposure**

Size		6	8	10	
<b>Characteristic resistance to pull-out failure and local brick failure of groups under fire exposure</b>					
$N^g_{Rk,fi} = N^g_{Rk,b,fi} = N^g_{Rk,p,fi}$	[kN]	R30-R90	$0,11 \times N^g_{Rk,b}$	$0,14 \times N^g_{Rk,b}$	$0,15 \times N^g_{Rk,b}$
		R120	$0,09 \times N^g_{Rk,b}$	$0,11 \times N^g_{Rk,b}$	$0,12 \times N^g_{Rk,b}$
Min. edge distance and spacing	[mm]	$C_{min,fi}$	$2 \times h_{nom}$		
		$S_{min,fi}$	107		

Application in the joint or near the joint according to Table C8.3, is not permitted under fire exposure.

fischer concrete screw UltraCut FBS II, FBS II CP, FBS II R  
for anchoring in the masonry

**Performance**

Solid brick KS NF, characteristic resistance under fire exposure

**Annex C 10**

Appendix 23 / 25

## Hollow brick KSL, 3DF, EN 771-2:2011+A1:2015

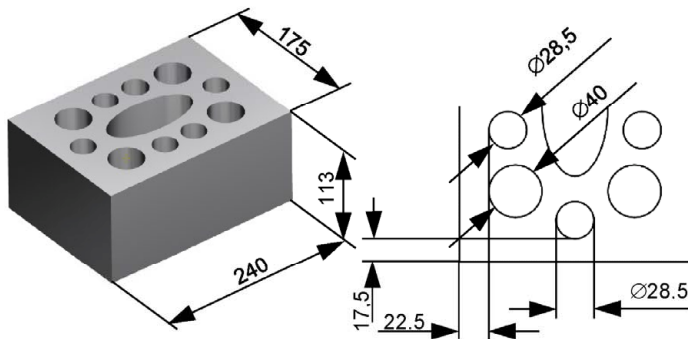

Hollow brick KS, 3DF, EN 771-2:2011+A1:2015			
Producer	e.g.f: KS H+H Durmersheim		
Nominal dimensions [mm]	length L	width B	height H
	240	175	113
Mean gross dry density $\rho$ [kg/dm <sup>3</sup> ]	≥ 1,4		
Mean compressive strength/ Min. compressive strength single brick <sup>1)</sup> [N/mm <sup>2</sup> ]	≥ 15/12		
Standard	EN 771-2:2011+A1:2015		

<sup>1)</sup> The compressive strength of the single brick must not be less than 80% of the mean compressive strength

**Table C11.1:** Installation parameters

Size		6	8	10	
<b>General Installation parameters</b>					
Nominal embedment depth	$h_{nom}$	[mm]	≥ 40	≥ 50	≥ 55
Effective embedment depth	$h_{ef}$		≥ 32	≥ 40	≥ 43
Maximum installation torque	$\max T_{inst}$	[Nm]	3	4	8
Torque impact screw driver	$T_{imp,max}$		65	65	65
fischer impact screw driver FSS 18V 400 BL level		[-]	level 1	level 1	level 1
<b>Edge distance and spacing</b>					
Minimum edge distance to free edge	$C_{min}$	[mm]	50	60	70
Minimum spacing	$S_{min II} = S_{min \perp}$		80	80	80
Characteristic spacing	$C_{cr}$		1,5 $h_{nom}$		
	$S_{cr II}; S_{cr \perp}$		$l_{unit}; h_{unit}$		

### Drilling mode

Hammer drilling or rotary drilling with standard hammer drill bit or hollow drill bit

**Table C11.2:** Group factors

Size		6	8	10	
Group factor	$\frac{\alpha_{g,N}}{\alpha_{g,V II} = \alpha_{g,V \perp}}$	[-]	2,0	2,0	2,0
			1,35	1,35	1,35

**Table C11.3:** Reduction factors depending on the distance to joints and the joint width

Size		6	8	10	6	8	10
Maximum joint width	$w_j$	[mm]	> 3			≤ 3	
Distance to joints	$C_{j \perp}$	[mm]	≥ 10			≥ 10	
	$C_{j II}$		≥ 40			≥ 40	
Joint factor	$\frac{\alpha_{j,N}}{\alpha_{j,V II} = \alpha_{j,V \perp}}$	[-]	1 (full resistance)		1 (full resistance)		
Distance to joints	$C_{j \perp}$	[mm]	< 10			< 10	
	$C_{j II}$		< 40			< 40	
Joint factor	$\frac{\alpha_{j,N}}{\alpha_{j,V II} = \alpha_{j,V \perp}}$	[-]	0 (Screw must not be used)			0,8	0,6

fischer concrete screw UltraCut FBS II, FBS II CP, FBS II R for anchoring in the masonry

### Performance

Hollow brick KSL 3DF, dimensions, installation parameters, group factors and joint factors

## Annex C 11

Appendix 24 / 25

## Hollow brick KSL, 3DF, EN 771-2:2011+A1:2015

**Table C12.1:** Characteristic resistance to pull-out failure or brick breakout failure of a single anchor under tension loading

Size		6	8	10
<b>Characteristic Tension resistance depending on the mean compressive strength of the brick</b>				
Mean compressive strength/ Min. compressive strength single brick <sup>1)</sup> [N/mm <sup>2</sup> ]	Use category	$N_{RK} = N_{RK,p} = N_{RK,b} = N_{RK,p,c} = N_{RK,b,c}$ [kN]		
≥ 12/10	wet	0,3	0,8	0,8
	dry	0,3	0,9	0,8
≥ 15/12	wet	0,4	0,9	0,9
	dry	0,4	1,0	0,9
≥ 20/16	wet	0,5	1,2	1,2
	dry	0,5	1,3	1,2
≥ 22/17,5	wet	0,6	1,3	1,3
	dry	0,6	1,4	1,3

<sup>1)</sup> The compressive strength of the single brick must not be less than 80% of the mean compressive strength.

**Table C12.2:** Characteristic resistance to local brick failure or brick edge failure of a single anchor under shear loading

Size		6	8	10			
<b>Characteristic shear resistance depending on the mean compressive strength of the brick</b>							
Mean compressive strength/ Min. compressive strength single brick <sup>1)</sup> [N/mm <sup>2</sup> ]	Use category	$V_{RK, \parallel}$ [kN]	$V_{RK, \perp}$ [kN]	$V_{RK, \parallel}$ [kN]	$V_{RK, \perp}$ [kN]	$V_{RK, \parallel}$ [kN]	$V_{RK, \perp}$ [kN]
≥ 12/10	wet or dry	2,8	1,6	2,3	1,8	2,7	1,3
≥ 15/12	wet or dry	3,3	1,9	3,6	2,0	4,3	2,0
≥ 20/16	wet or dry	4,1	2,3	4,9	2,3	5,8	2,7
≥ 22/17,5	wet or dry	4,4	2,5	5,2	2,4	6,2	2,9

### Resistance to combined tension and shear loading (hollow and perforated bricks)

Limit value for interaction	X	[-]	1,3
-----------------------------	---	-----	-----

<sup>1)</sup> The compressive strength of the single brick must not be less than 80% of the mean compressive strength.

**Table C12.3:** Displacements under tension and shear loads

Size			6	8	10
Displacement-factor under tension load	$\delta_{N0}$ -Factor	[mm/kN]	0,2	0,2	0,3
	$\delta_{N\infty}$ -Factor		0,4	0,4	0,6
Displacement-factor under shear load	$\delta_{V0}$ -Factor		1,25	1,0	1,0
	$\delta_{V\infty}$ -Factor		1,88	1,5	1,5

Calculation of effective displacement:

$$\delta_{N0} = \delta_{N0}\text{-Factor} \times N \text{ [mm]}$$

$$\delta_{N\infty} = \delta_{N\infty}\text{-Factor} \times N \text{ [mm]}$$

N = Acting tension load

$$\delta_{V0} = \delta_{V0}\text{-Factor} \times V \text{ [mm]}$$

$$\delta_{V\infty} = \delta_{V\infty}\text{-Factor} \times V \text{ [mm]}$$

V = Acting shear load

fischer concrete screw UltraCut FBS II, FBS II CP, FBS II R for anchoring in the masonry

### Performance

Hollow brick KSL 3DF, characteristic resistance under tension and shear loading, stiffnesses and displacements

## Annex C 12

Appendix 25 / 25